 www.amarjacquard.com

®



AMAR JACQUARD
SINCE 1975



Supera
Compass
Pro+

“Leading technology in
textile weaving machines”

ABOUT US



AMAR JACQUARD
SINCE 1975

AMAR JACQUARD is Trendsetter in design & manufacturer of electronic jacquard's complete range like **CAMARO Series, GRAVITY Series, Supra Series, Compass Series** in all hooks with advance weaving technology for all types of designing fabrics.

Throughout the history of **AMAR JACQUARD** our philosophy remains unchanged, continual investment in Quality and R&D. This resulted in the invention of the automatic electronic jacquard years ago.

AMAR JACQUARD is on the drafting committee for national electronic jacquard industry standard. Products are used in the whole country and exported to **South American Region:** Ecuador, Peru, Chile, Bolivia as well as **Middle east:** Turkey, UAE. **Asian Region:** Bangladesh, Nepal, Sri Lanka, Indonesia, Malaysia, Uzbekistan, Turkmenistan, Afghanistan.

Our main products range are: HIGH SPEED ELECTRONIC JACQUARD, HIGH SPEED RAPIER LOOM, NAME WRITER JACQUARD, TUCK-IN DEVICE, CRANK BASED RAPIER LOOM, AIRJET LOOM and all Accessories.

Fabrics can Produce are: Woolen Shawls, Stoles, Scarves, Suits, Saree, Blankets, Curtains, Carpets Dress Materials, Sherwanis, Cloth Fabrics & Technical Fabrics.

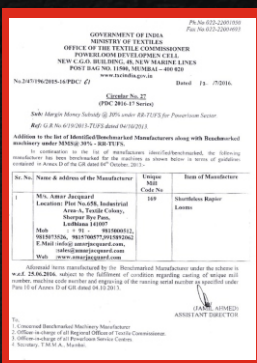
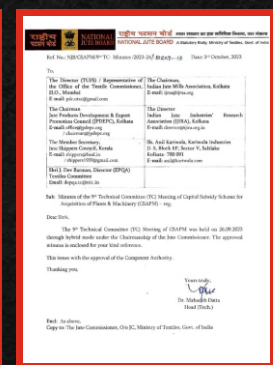
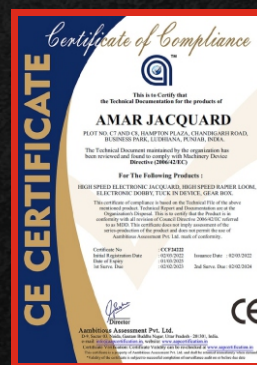
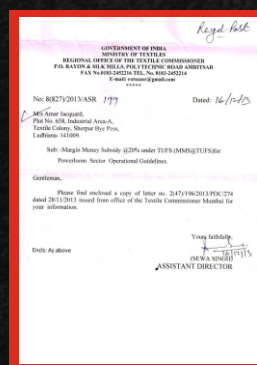
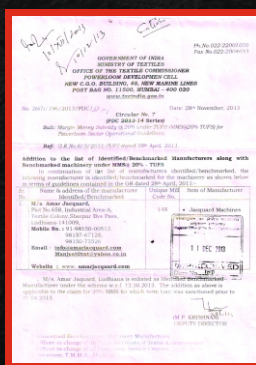



AMAR JACQUARD
SINCE 1975

AMAR JACQUARD asserts its position as a global innovator by:-

- Offering customers the best products and services in terms of both quality and performance.
- Actively supporting initiatives aimed at improving products and services.
- Maintaining synergy between the needs of customers, suppliers, shareholders staff and environmental concerns.

Innovation is **AMAR'S** Driving Force. In our constant search for excellence, we expand our expertise and experience in manufacturing by designing, producing, selling and providing support for products and systems in markets where high productivity levels are essential. The company is continuously investing in latest technology to adopt 4.0 Industry standards.



Our skilled workforce operates with precision, dedication, and a commitment to delivering world-class quality.



Every product is crafted in a clean, organized, and technologically advanced manufacturing environment.



We believe that hardworking teams and modern infrastructure are the foundation of consistent customer satisfaction



Our production facility follows strict quality standards to ensure efficiency, accuracy, and reliable performance.



With experienced staff and advanced machinery, we continuously strive for innovation and manufacturing excellence.



A safe, disciplined, and positive work culture empowers our team to achieve superior results for every client.

Supra
SMART - E - SERIES



®

AMAR JACQUARD
SINCE 1975

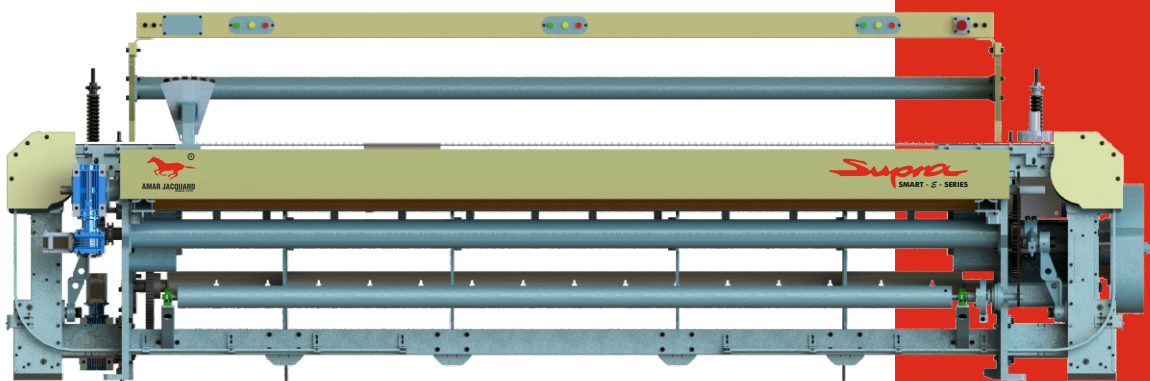
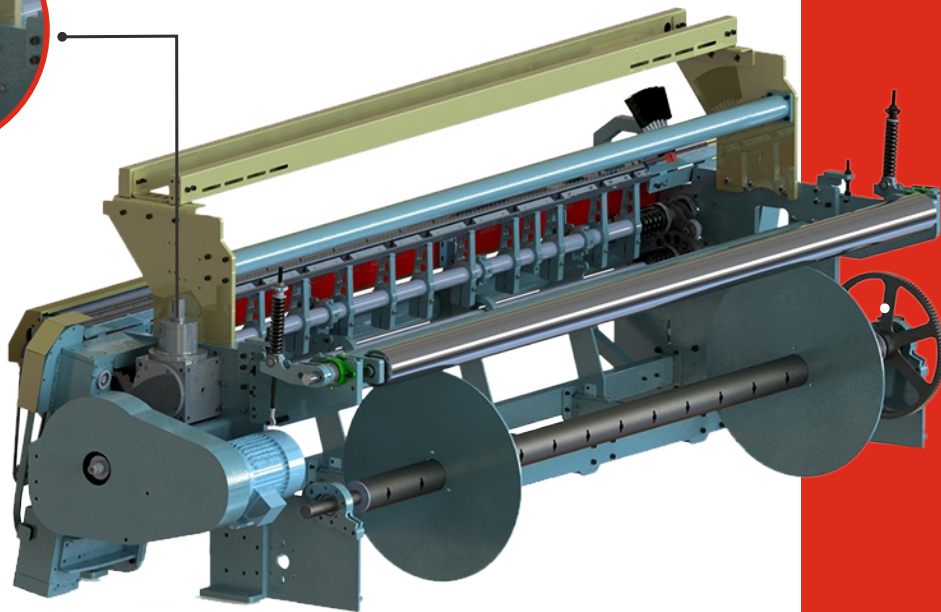
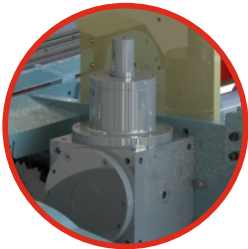

“India’s 1st *Cam Beating* Rapier Loom”

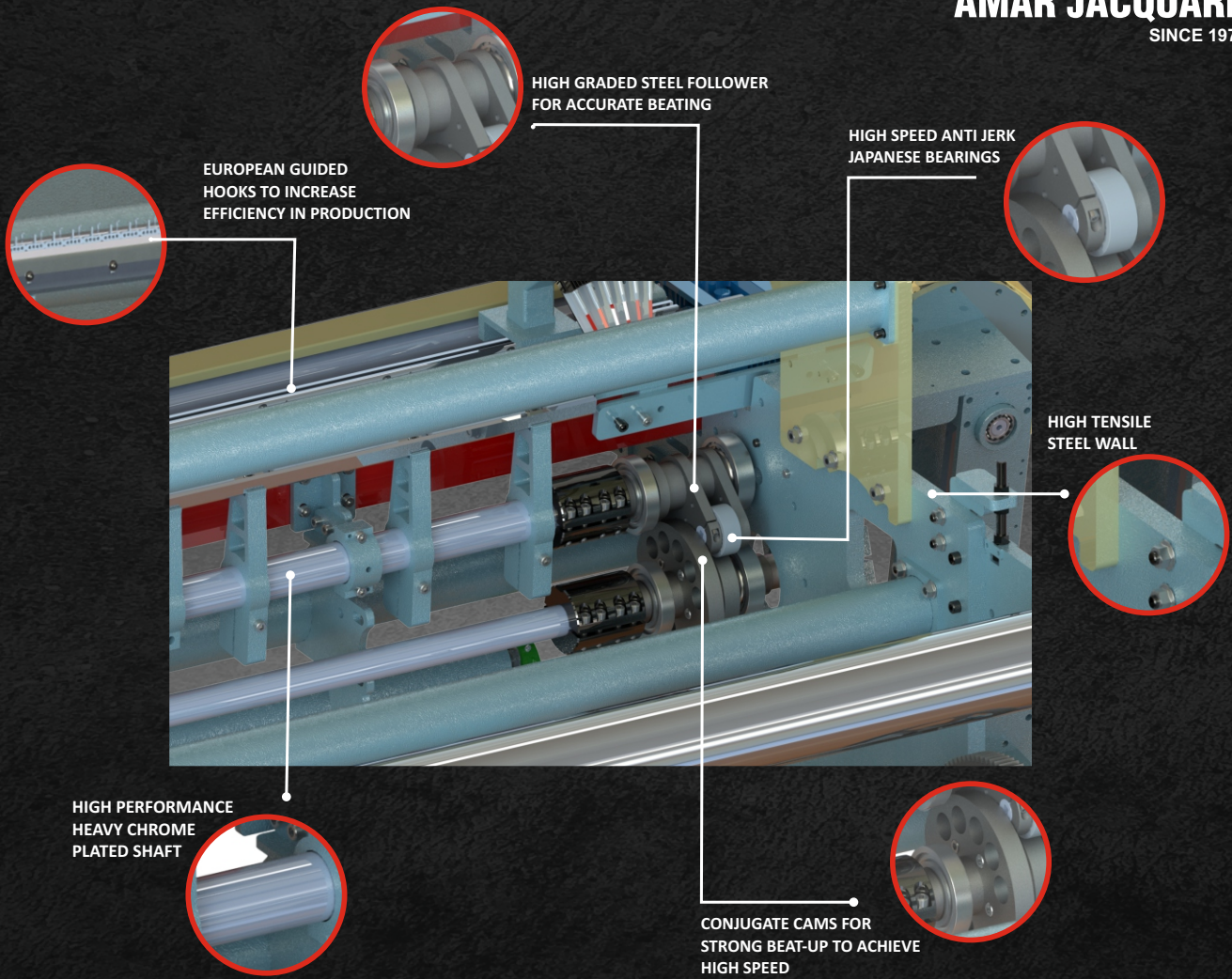

Model:
Supra
SMART - E - SERIES

- 150 CM - 60 INCH • 180 CM - 72 INCH
- 230 CM - 90 INCH • 280 CM - 110 INCH
- 320 CM - 128 INCH • 360 CM - 144 INCH

Model:
Supra
SMART - M - SERIES

- 150 CM - 60 INCH • 180 CM - 72 INCH
- 230 CM - 90 INCH • 280 CM - 110 INCH
- 320 CM - 128 INCH • 360 CM - 144 INCH

Speed: 250 Rpm in Narrow width loom, 220 Rpm in wider width loom.

Shedding: Jacquard up to 12028 Hooks Amar Cam motion 4 frames, Amar Electronic Dobby

Let Off & Take Up Electronic and Mechanical.

Low Maintenance

Jacquard Driving: Drive Through Cardon Shaft & Gearbox

Auto pick finding possibility in **SUPRA-E** Model

Electronic Density and Creaming with Servo motor drive.

Electronic weft selector 6 or 8 colors

IE4 Power Saving German Technique Motor

Weft Insertion: European Rapier head & Guided hooks to increase efficiency in production

Pick Density: 8 Picks per inch. Max 450zz Picks per inch

No need of any Lubrication, Machine is totally Bearing Based.

Applicable Yarn: Polyester, Viscose, Acrylic, Silk, Roto, Wool, Cotton Yarn & Other Synthetic Yarns.

Equipt with Japanese Bearings

ELECTRONIC JACQUARD COMPASS Pro+



AMAR JACQUARD
SINCE 1975

Amar Electronic Jacquard machines Compass Model are ideal for weaving flat Fabrics on Shuttle Loom and Crank type Rapier Loom. They produce excellent results in nearly all applications whether with Terry Cloth, Sarees, Shawls, Stolls etc.

Advantages

- The Jacquard machines Compass Pro+ is very Robust, Wear-resistant and designed for many years of daily use with a minimum of maintenance.
- Quick and Easy to install.
- Precise Kinematics with No Vibration.
- Low Friction Engineering reduces Energy Consumption.
- Safe, Straight Forward Access to make Machine Adjustment.

Drive system & shedding - Double Lift open shed Jacquard Machine

- Model available are 448, 640, 704, 960, 1344, 1536, 1793, 2048, 2688, 3072, 3648, 4032, 3370, 6144.
- Precise Adjustment of Shed Geometry.
- Main Drive Available With Chain System.
- High Quality Aluminum Blades for Low Vibration
- Shedding option from 75mm to 115mm.

Amar Jacquard Mechanism is solid structure mechanism. All the material of Gears, iron and Casting are well tested material. All bearings are made of well known brands like NSK and ARB.

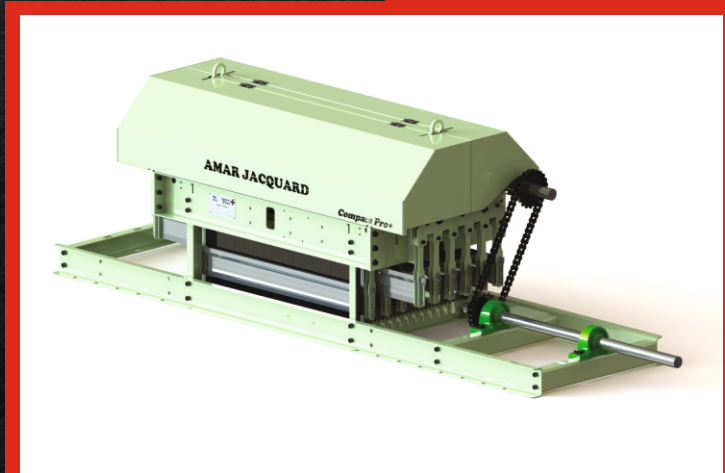

ELECTRONIC JACQUARD

COMPASS Pro+



AMAR JACQUARD
SINCE 1975

Amar Electronic Jacquard machines Compass Model are ideal for weaving flat Fabrics on Shuttle Loom and Crank type Rapier Loom. They produce excellent results in nearly all applications whether with Terry Cloth, Sarees, Shawls, Stolls etc.

Advantages

- The Jacquard machines Compass Pro+ is very Robust, Wear-resistant and designed for many years of daily use with a minimum of maintenance.
- Quick and Easy to install.
- Precise Kinematics with No Vibration.
- Low Friction Engineering reduces Energy Consumption.
- Safe, Straight Forward Access to make Machine Adjustment.

Drive system & shedding - Double Lift open shed Jacquard Machine

- Model Available are 448, 640,704,960, 1344, 1536, 1793, 2048, 2688, 3072, 3648, 4032, 3370, 6144.
- Precise Adjustment of Shed Geometry
- Main Drive Available With Chain System.
- High Quality Aluminum Blades for Low Vibration
- Shedding option from 75mm to 115mm

Amar Jacquard Mechanism is solid structure mechanism. All the material of Gears, iron and Casting are well tested material. All bearings are made of well known brands like NSK and ARB.

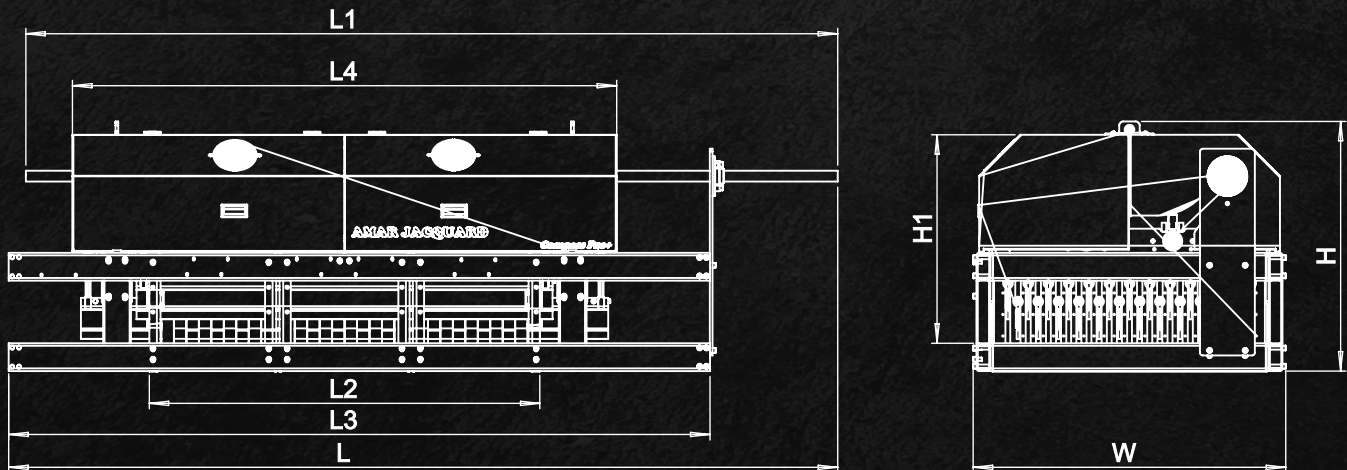

MODEL	L1	L2	L3	L4	L	H1	H	W
1792	2420	734	2050	1315	2507	742	895	800
2048	2600	850	2140	1406	2592	742	895	800
2688	2600	1078	2140	1634	2592	742	895	800
3072	2733	1214	2270	1805	2727	742	895	800
4032	3000	1080	2561	1625	3018	762	912	1120
5376	3000	1427	2561	1988	3018	762	912	1120

Note- All sizes in mm.



AMAR JACQUARD
SINCE 1975

MANUFACTURING PLANT & CORPORATE OFFICE

D9 To D14, Hampton Court, Business Park, Near Fortis Hospital,
Chandigarh Road, Ludhiana - 141012, Punjab, INDIA.

☎ +91 - 98150-00512 | 98157-00577

✉ info@amarjacquard.com | sales@amarjacquard.com |

🌐 www.amarjacquard.com

BRANCH OFFICE

BANGALORE (KARNATKA)

Ground Floor, 441/90/1A1, Division20, Veerabhadrana Palya,
Doddaballapur, Karnataka, 561203 Thyagarajanagar,
Doddaballapuram, Bangaluru (Banglore) Rural,
Karnataka - 561203.

VARANASI (BANARAS)

Chandapur, Charampur, Lohta, Varanasi, (U.P)

KOLKATA (WEST BENGAL)

Bag Devipur Santipur, Nadia, Kolkata

SURAT (GUJRAT)

Laxmi Villa Township, CF-10, E-Building, Road No. 9, B/H, GIDC SACHIN, Surat

BELGAUM (KARNATKA)

Near Industrial Co-op, Bank, Basveshwar Circle, Khasbag, Belgaum

HINDUPUR, ANANTHA PURA (ANDRA PRADESH)

M.r. Palli, Hindupura, Anantha Pura, Andra Pradesh - 515201.

SALEM (TAMILNADU)

Elmpillai Road, Sankari (T.K), Salem (D.T)

INTERNATIONAL BRANCH OFFICE

BANGLADESH (SIRAJGANJ)

Nur Islam House, 1st Floor, Shernagar, Belkuchi, Sirajganj

BOLIVIA (SOUTH AMERICA)

58, Villa Avaroa, Street 139N, El Alto, La Paz, Bolivia

NEPAL (SIRAJGANJ)

JORPATI, KATHMANDU (NEPAL)



Click here for
more information